

PLUG & PLAY PLUS

Ø 45

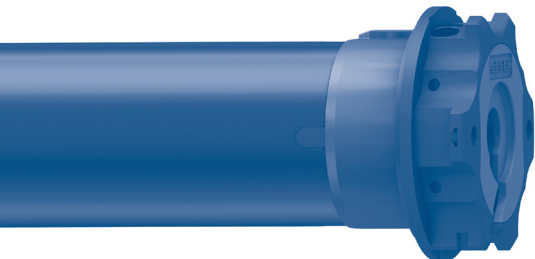

MOTORE TUBOLARE CON REGOLAZIONE MANUALE
O AUTOMATICA DEL FINECORSO ELETTRONICO

IT

TUBULAR MOTOR WITH MANUAL OR AUTOMATIC
ADJUSTMENT OF THE ELECTRONIC LIMIT SWITCH

EN

ROHRMOTOR MIT MANUELLER ODER AUTOMATISCHER
EINSTELLUNG DER ELEKTRONISCHEN ENDLAGEN

DE

MOTEUR TUBULAIRE AVEC RÉGLAGE MANUEL
OU AUTOMATIQUE DES FINS DE COURSE ÉLECTRONIQUES

FR

MOTOR TUBULAR CON REGULACIÓN MANUAL
O AUTOMÁTICA DEL FIN DE CARRERA ELECTRONICO

ES

Table of contents:

Electrical connections	p. 13
How to prepare the motor	p. 14
Key to symbols	p. 15
Command sequences example	p. 15
Limit switch learning	p. 16
Limit switch learning in automatic mode	p. 16
Limit switch setting in manual mode	p. 17
Procedure for limit switch setting in manual mode	p. 17
Example 1: Setting as first the upper limit switch	p. 17
Example 2: Setting as first the lower limit switch	p. 17
Limit switch setting in mixed mode	p. 18
Changing limit switches	p. 19
Deleting of single limit switch positions	p. 19
Deleting of all limit switch positions	p. 19
Motor actions at limit switch stops and obstacles	p. 20
Restoring the original configuration	p. 20

EU DECLARATION OF CONFORMITY

CHERUBINI S.p.A. declares that the product is in conformity with the relevant Union harmonisation legislation:

Directive 2014/35/EU

Directive 2014/30/EU

Directive 2011/65/EU

The full text of the EU declaration of conformity is available upon request at the following website: www.cherubini.it.

ELECTRICAL CONNECTIONS

- To prevent any danger or malfunction, the size of electrical control components connected to the motor must be compatible with the electrical features of the motor.
- Means for disconnection must be incorporated in the fixed wiring in accordance with the national installation standards.
- The selectors inverting the direction of rotation of the motor must be provided with mechanical interlocking.
- Invert the brown and the black conductor to change the direction of rotation.
- **NEVER** connect two or more selectors to the same motor.
- For outdoor use, provide the appliance with a supply cord with designation H05RN-F containing at least 2% of carbon.
- Cable length between motor and control-switch maximal 50 m.
In case of cable length more than 50 m an interface-relay have to be used.

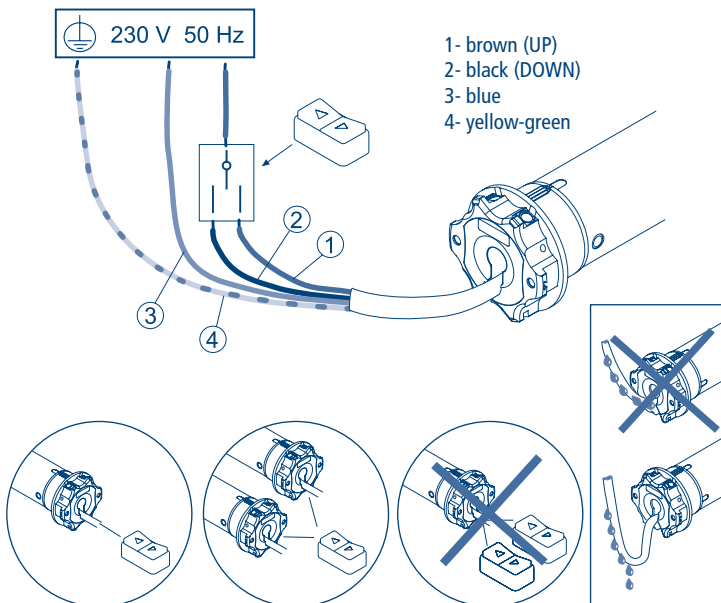

HOW TO PREPARE THE MOTOR

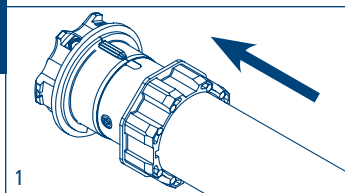
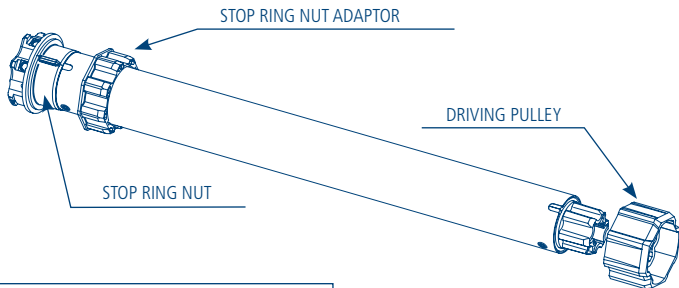

1. Insert the adaptor in the stop ring nut mating the groove with the reference notch and push till they touch.

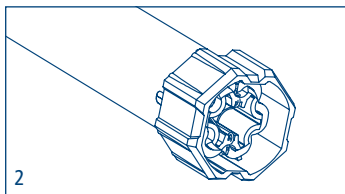

2. Fix the driving pulley on the motor pin until the stop pin clicks.

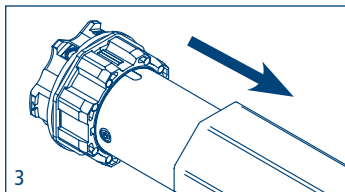

3. Insert the motor fully in the rolling tube.

NB: If you use tubes with a round form, the driving pulley must be fixed to the tube, and the installation is to be paid by the person who installs the system. For other tube sections the fitting is optional, but strongly recommended.

KEY TO SYMBOLS

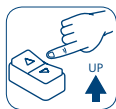

Press the
UP-button

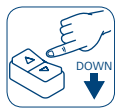

Press the
DOWN-button

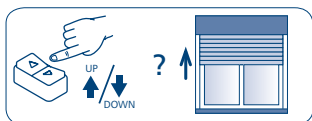
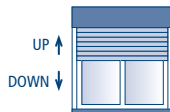

Press the up or down buttons to raise
the blind.



Motor
rotation to
confirm

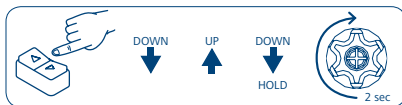

Press the buttons as indicated in rapid sequence and hold
the button down at the step marked by "HOLD", to check
the motor confirmation movement.

COMAND SEQUENCES EXAMPLE

Most of the command sequences have three or six distinct steps.
The buttons should be pressed quickly (<0.5 sec) as indicated in the sequence.
The time interval between each step should not be more than 1 second, otherwise the
command sequence will be cancelled.
To receive confirmation that the sequence has been accepted by the motor, the button
must be held down at the final step marked by HOLD.

Command sequence example in 3 steps:

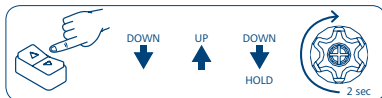

Attention! If the sequence requires a repetition of the same commands
(Up+Up/Down+Down), an interposition of the Stop position could be necessary
depending on the type of switch in use.

LIMIT SWITCH LEARNING

The motor can learn the limit switches in different modes: automatic, manual, mixed. It is suggested that the strength of the rolling shutter, its couplings and its safety lugs be checked.

As long as both of the limit switch positions have not been learned, the motor will move briefly, stop and then start back up again.

LIMIT SWITCH LEARNING IN AUTOMATIC MODE

To learn the limit switches in automatic mode, the rolling shutter must have either internal or external safety lugs (A).

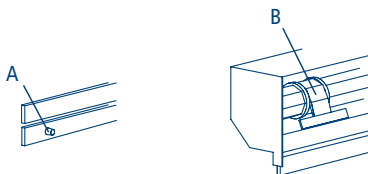

Run two ascending and descending complete cycles until the motor full stop in the limit switch and the pull is released.

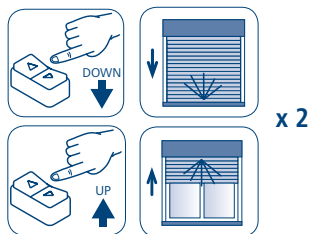

LIMIT SWITCH SETTING IN MANUAL MODE

Learning the limit switches in manual mode is required for rolling shutters that do not have either internal or external safety lugs (A).

Either flexible (B) or rigid (C) ribs may be used for the connection to the tube.

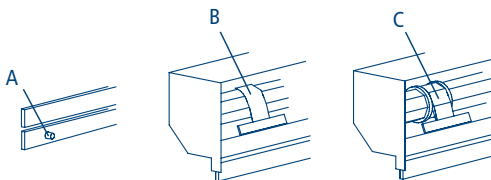

PROCEDURE FOR LIMIT SWITCH SETTING IN MANUAL MODE

Depending on your individual needs, it's possible to learn first either the upper or the lower limit switch.

EXAMPLE 1

SETTING AS FIRST THE UPPER LIMIT SWITCH

If the rolling shutter is completely open, you have first to drive it down by around 20 cm.

Using the button switch, put the rolling shutter to the upper desired position and to memorise, perform the indicated sequence of commands; (UP-UP-UP).

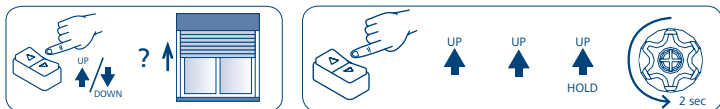

Using the button switch, put the rolling shutter to the lower desired position and to memorise, perform the indicated sequence of commands; (DOWN-DOWN-DOWN).

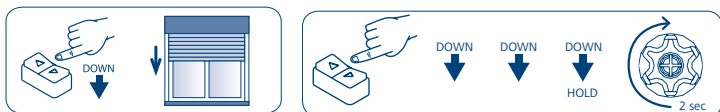

EXAMPLE 2: SETTING AS FIRST THE LOWER LIMIT SWITCH

If the rolling shutter is completely down, you have first to drive it up by around 20 cm.

Using the button switch, put the rolling shutter to the lower desired position and to memorise, perform the indicated sequence of commands; (DOWN-DOWN-DOWN).

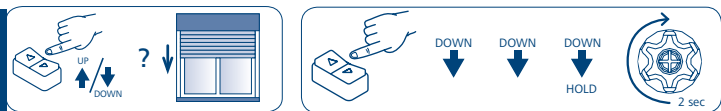

Using the button switch, put the rolling shutter to the upper desired position and to memorise, perform the indicated sequence of commands; (UP-UP-UP).

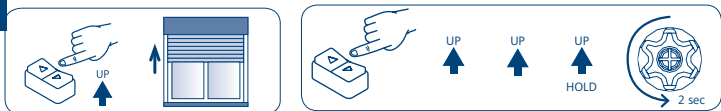

LIMIT SWITCH SETTING IN MIXED MODE

Where required for, the limit switch positions can be set in mixed mode.

EXAMPLE: SETTING AS FIRST THE UPPER LIMIT SWITCH IN MANUAL MODE AND THE LOWER LIMIT SWITCH IN AUTOMATIC MODE

If the rolling shutter is completely open, you have first to drive it down by around 20 cm.

Using the button switch, put the rolling shutter to the upper desired position and to memorise, perform the indicated sequence of commands; (UP-UP-UP).

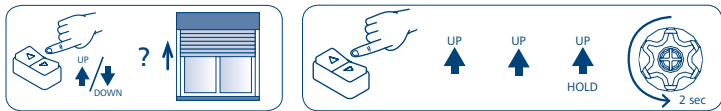

Using the down button drive the rolling shutter to the complete lower position twice, allowing the motor to automatically detect the limit switch.

CHANGING LIMIT SWITCHES

The following command sequences may be performed only after the limit switches have been learned and only when the motor is completely on one of the two limit switch positions: either lower or upper limit positions.

DELETING OF SINGLE LIMIT SWITCH POSITIONS

Deleting the UPPER limit starting from the UPPER limit switch position

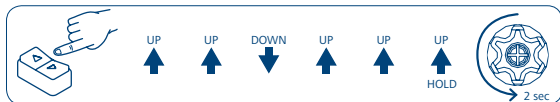

Deleting the LOWER limit starting from the LOWER limit switch position

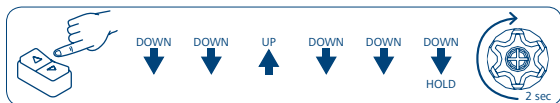

DELETING OF ALL LIMIT SWITCH POSITIONS

Deleting both limit switch position starting from the UPPER limit

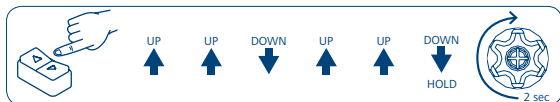

Deleting both limit switch position starting from the LOWER limit

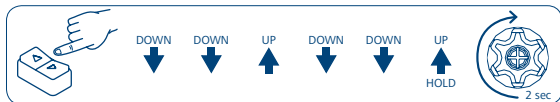

Deleting of one or both limit switches is indicated by the motor pausing briefly before moving again until both limit switch positions have been memorised again.

MOTOR ACTIONS AT LIMIT SWITCH STOPS AND OBSTACLES

	LIMIT SWITCH STOPS (rolling shutters with stoppers and/or stiff fixing springs).	OBSTACLE DETECTION WHEN ASCENDING AND DESCENDING (only when descending for rolling shutters with stiff fixing springs).
Plug&Play Plus	Normally stops a few mm before touching the stop. Occasionally, it goes to the stop and then slightly reverses itself to decrease the force.	It stops and slightly reverses itself to decrease the force.

RESTORING THE ORIGINAL CONFIGURATION

PLEASE NOTE: recovery of the default configuration will delete the limit switches and disabling the super-sensitivity.

To restore the original motor configuration perform the procedure as described below:

- Connect both the brown and black motor wires under the same switch, e.g. UP.

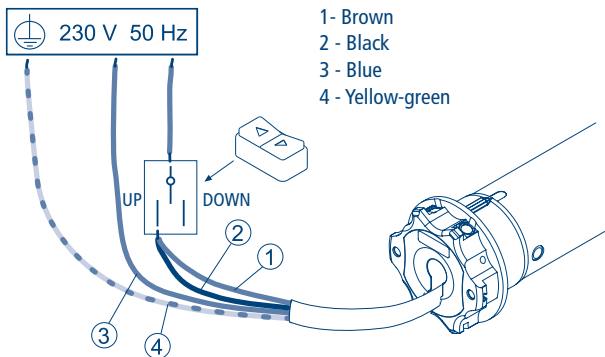

- Press the UP button for at least 2 seconds.
- Disconnect and then restore the original control switch electrical connections (see page 13).

CHERUBINI S.p.A.

Via Adige 55
25081 Bedizzole (BS) - Italy
Tel. +39 030 6872.039 | Fax +39 030 6872.040
info@cherubini.it | www.cherubini.it

CHERUBINI Iberia S.L.

Avda. Unión Europea 11-H
Apdo. 283 - P. I. El Castillo
03630 Sax Alicante - Spain
Tel. +34 (0) 966 967 504 | Fax +34 (0) 966 967 505
info@cherubini.es | www.cherubini.es

CHERUBINI France S.a.r.l.

ZI Du Mas Barbet
165 Impasse Ampère
30600 Vauvert - France
Tél. +33 (0) 466 77 88 58 | Fax +33 (0) 466 77 92 32
info@cherubini.fr | www.cherubini.fr

CHERUBINI Deutschland GmbH

Siemensstrasse, 40 - 53121 Bonn - Deutschland
Tel. +49 (0) 228 962 976 34 / 35 | Fax +49 (0) 228 962 976 36
info@cherubini-group.de | www.cherubini-group.de

