

# CHERUBINI

tocco italiano dal 1947

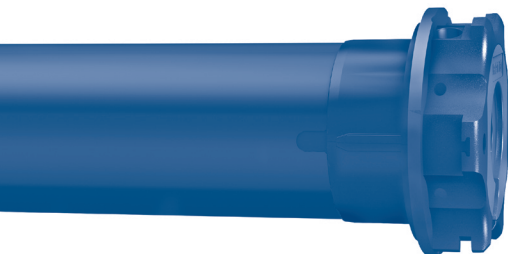

## MODO RX



MOTORE TUBOLARE PER AVVOLGIBILI CON  
FINECORSO ELETTRONICO

**IT**

TUBULAR MOTOR WITH ELECTRONIC LIMIT SWITCH  
FOR ROLLING SHUTTERS

**EN**

ROHRMOTOR FÜR ROLLADEN MIT  
ELEKTRONISCHER ENDLAGENEINSTELLUNG

**DE**

MOTEUR TUBULAIRE POUR VOLET ROULANT  
AVEC FINS DE COURSE ÉLECTRONIQUES

**FR**

MOTOR TUBULAR PARA PERSIANA CON  
FIN DE CARRERA ELECTRÓNICO

**ES**



ISTRUZIONI - INSTRUCTIONS - EINSTELLANLEITUNGEN  
INSTRUCTIONS - INSTRUCCIONES



**Table of contents:**

How to prepare the motor .....	p. 22
Electrical connections .....	p. 23
Compatible remote controls / Key to symbols .....	p. 24-25
Command sequences example .....	p. 25
Function open/close programming remote control .....	p. 26-27
Setting the first remote control .....	p. 28
Automatic disabling of the first remote control setting function .....	p. 28
Adjustment of the limit switches .....	p. 28
Example 1: Setting first the opening position .....	p. 29
Example 2: Setting first the closing position .....	p. 30
Setting a middle position .....	p. 31
Deleting the middle position .....	p. 31
Closing force adjustment .....	p. 32
Maximum closing force adjustment (100%) .....	p. 32
Deleting the limit switch positions .....	p. 33
Deleting the opening limit switch .....	p. 33
Deleting the closing limit switch .....	p. 33
Total deleting of the limit switches .....	p. 33
Setting of additional remote controls .....	p. 34
Remote control memory clearing .....	p. 35
Full memory clearing .....	p. 35
Short-term setting of a remote control .....	p. 36
Electric wiring to motor command with 2 independent buttons .....	p. 37
Command management from white wire	
UP-STOP-DOWN-STOP / UP-DOWN / UP-DOWN "Dead Man" .....	p. 38

**EU DECLARATION OF CONFORMITY**

**CE** CHERUBINI S.p.A. declares that the product is in conformity with the relevant Union harmonisation legislation:

Directive 2014/53/EU, Directive 2011/65/EU.

The full text of the EU declaration of conformity is available upon request at the following website: [www.cherubini.it](http://www.cherubini.it).

## HOW TO PREPARE THE MOTOR

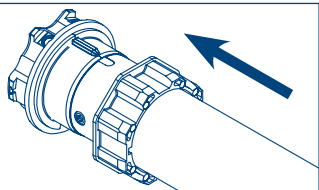
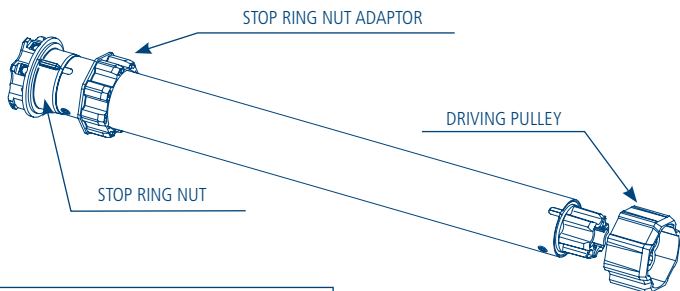

1. Insert the adaptor in the nut mating the groove with the reference notch and push till they touch.

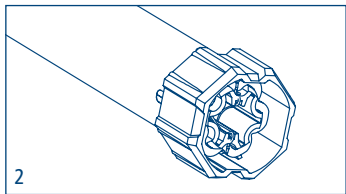

2. Fix the driving pulley on the motor pin until the stop pin clicks.

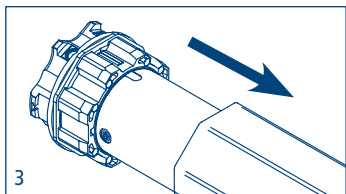

3. Insert the motor fully in the rolling tube.

**NB:** If you use tubes with a round form, the driving pulley must be fixed to the tube, and the installation is to be paid by the person who installs the system. For other tube sections the fitting is optional, but strongly recommended.

## ELECTRICAL CONNECTIONS

- In order to prevent dangerous situations or malfunctioning, the electrical command elements wired to the motor must be sized according to the motor's electrical features.
- Means for disconnection must be incorporated in the fixed wiring in accordance with the national installation standards.
- For outdoor use, provide the appliance with a supply cable with designation H05RN-F containing at least 2% of carbon.
- If not used, the white wire must be insulated. It is dangerous to touch the white wire when the motor is powered.

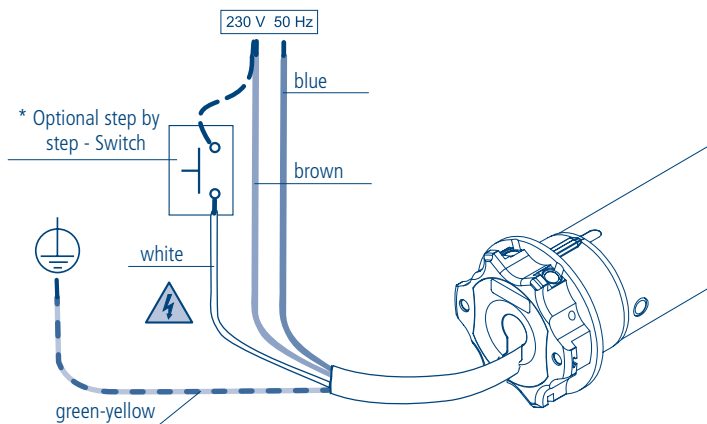

- \* Installing this switch is optional. The connection can be done differently using the brown wire or the blue wire. The switch affords the possibility to command the motor in stepping mode (up, stop, down, stop, up, stop, down, stop..)

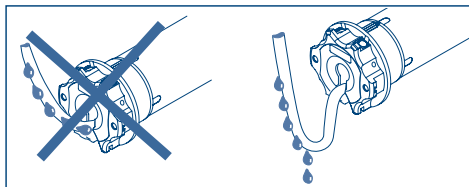

# COMPATIBLE REMOTE CONTROLS

**GIRO**

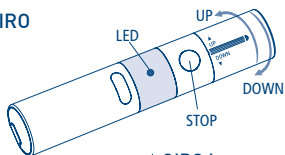

**GIRO Wall**

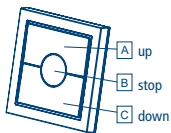

**GIRO Plus**

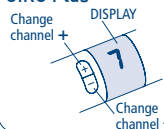

**GIRO Lux**

Activating the Sun sensor



**GIRO P-Lux**

Change channel

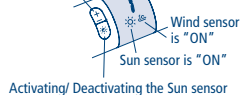

**POP**

**POP Lux**

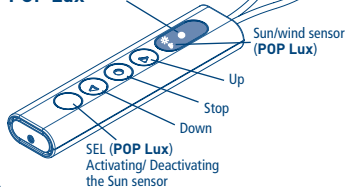

**POP Plus**

**POP P-Lux**

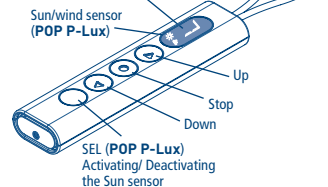

SKIPPER  
SKIPPER **LUX**  
SKIPPER **PLUS**  
SKIPPER **P-LUX**

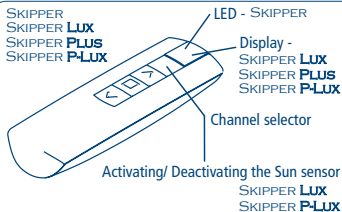

SKIPPER **LCD**  
SKIPPER **SENSO**

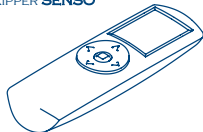

Check the specific instruction book

## KEY TO SYMBOLS

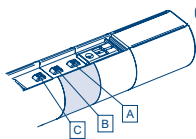

**GIRO**

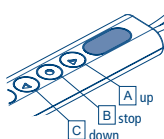

**POP**

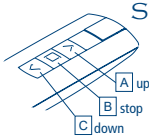

**SKIPPER**



## KEY TO SYMBOLS

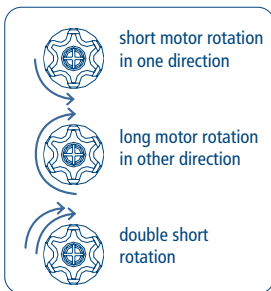
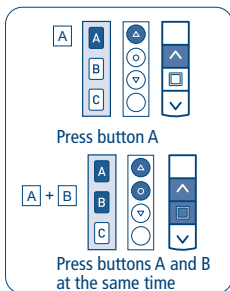
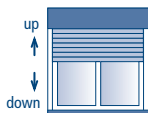

## COMMAND SEQUENCES EXAMPLE

Most of the command sequences have three distinct steps, at the end of which the motor indicates if the step has been concluded positively or not, by turning in different ways. This section is provided to demonstrate the motor indications. The buttons must be pressed as shown in the sequence, without taking more than 4 seconds between one step and the next. If more than 4 seconds are taken, the command is not accepted and the sequence must be repeated. Command sequence example:

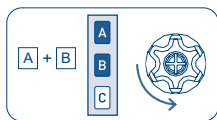

Step 1

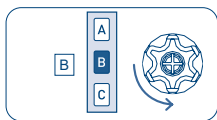

Step 2

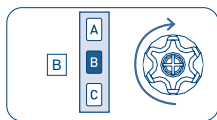

Step 3

As we can see from the example, when the sequence ends positively, the motor returns to its starting position in one long rotation. In fact, two short rotations in the same direction correspond to one long rotation in the opposite direction. The motor returns to the starting position even when the sequence is not completed; in this case by performing one or two short rotations. Example of a wrong sequence:

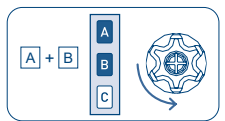

Step 1

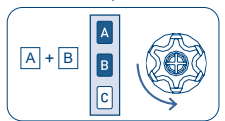

Step 1

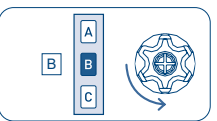

Step 2



# FUNCTION OPEN/CLOSE PROGRAMMING

## REMOTE CONTROL SKIPPER PLUS - SKIPPER LUX - SKIPPER P-LUX

## REMOTE CONTROL POP PLUS - POP LUX - POP P-LUX

To prevent accidental changes to the programming of the motor during the daily use of the remote control, the possibility of programming is disabled automatically 8 hours after sending the last sequence (A+B or B+C).

### CHECKING THE STATUS OF THE FUNCTION

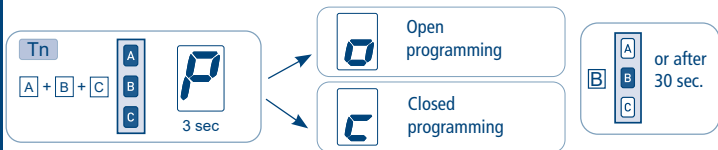

To change the status of the function, see the sequences "ENABLE/DISABLE PROGRAMMING".

### ENABLE PROGRAMMING

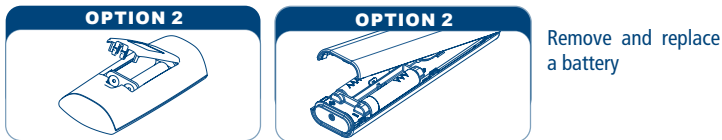

Proceed with programming as the instructions booklet.

### DISABLE PROGRAMMING





## FUNCTION OPEN/CLOSE PROGRAMMING REMOTE CONTROL SKIPPER - SERIES GIRO - REMOTE CONTROL POP

To prevent accidental changes to the programming of the motor during the daily use of the remote control, the possibility of programming is disabled automatically 8 hours after sending the last sequence (A+B or B+C).

### CHECKING THE STATUS OF THE FUNCTION

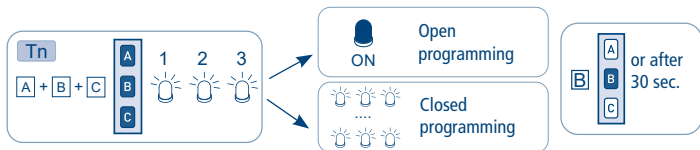

To change the status of the function, see the sequences "ENABLE/DISABLE PROGRAMMING".

### ENABLE PROGRAMMING

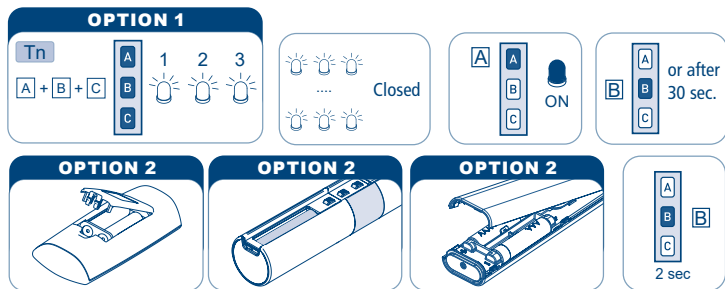

Remove one battery and wait minimum 5 seconds or press any button.

Proceed with programming as the instructions booklet.

### DISABLE PROGRAMMING



## SETTING THE FIRST REMOTE CONTROL

This operation can only be performed when the motor is new, or after a total delete of the memory.

**During this step, power up only one motor at time!**

T1: First remote control to be set

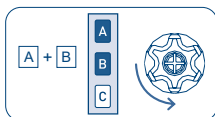

T1

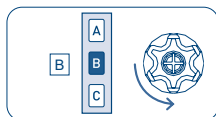

T1

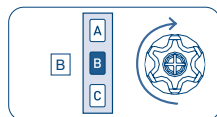

T1 (2 sec)

## AUTOMATIC DISABLING OF THE FIRST REMOTE CONTROL SETTING FUNCTION

Every time you connect the power supply to the motor, you have 3 hours to store the first remote control. After this time, the ability to store the remote control is disabled. To reset the timer of the function you have to disconnect and reconnect the power supply to the motor.

## ADJUSTMENT OF THE LIMIT SWITCHES

Tubular motors have an electronic limit switch system with an encoder. This system ensures great reliability and precision in keeping the positions. Limit switch regulation is performed simply with the remote control. During setting, the motor moves only as long as the up or down button is pressed, stopping when the button is released. At the end of setting, press either the up or down button briefly to move the motor.

It doesn't matter whether or not the rolling shutter has got physical stops in the opening position and the lockdown hangers in the closing position.

It is possible to choose whether to set the upper limit or the lower limit first.

The correct rotation direction will only be identified after the first position is set so it is sometimes necessary to use the "up" or "down" button.

## EXAMPLE 1: Setting first the opening position

### SETTING THE OPENING POSITION

If the rolling shutter is completely open, you have first to drive it down by around 20 cm.

Hold the button A or C pressed and drive the rolling shutter to the opening position.

**With physical stops:** press button A or C until the motor stops automatically.

**Without physical stops:** use the button A or C to drive the rolling shutter to the necessary opening position.

To set the opening position, press buttons A (up) and B (stop) simultaneously for about 2 seconds, until the motor automatically performs a short "down" movement.

This move is the visual confirmation of the setting operation.

Tn: Already programmed remote control

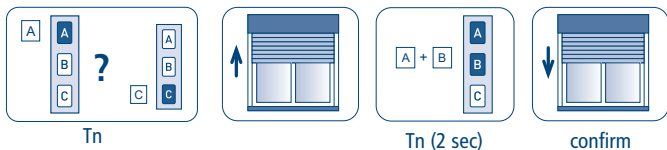

### SETTING THE CLOSING POSITION

Pressing now the button C, drive completely down the rolling shutter to the closing position.

**With lockdown hangers:** press button C until the motor stops automatically.

**Without lockdown hangers:** use the button A or C to drive the rolling shutter to the necessary closing position.

To set the closing position, press buttons B (stop) and C (down) simultaneously for about 2 seconds, until the motor automatically performs a short "up" movement.

This move is the visual confirmation of the setting operation.

Tn: Already programmed remote control

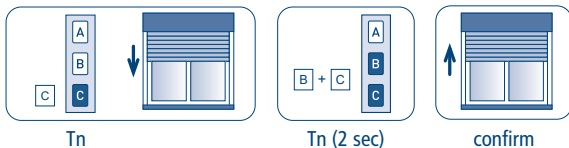

## EXAMPLE 2: Setting first the closing position

### SETTING THE CLOSING POSITION

If the rolling shutter is completely closed, you have first to drive it up by around 20 cm.

Hold the button A or C pressed and drive the rolling shutter to the closing position.

**With lockdown hangers:** press buttons A or C until the motor stops automatically.

**Without lockdown hangers:** use the button A or C to drive the rolling shutter to the necessary closing position.

To set the closing position, press buttons B (stop) and C (down) simultaneously for about 2 seconds, until the motor performs automatically a short "up" movement.

This move is the visual confirmation of the setting operation.

Tn: Already programmed remote control

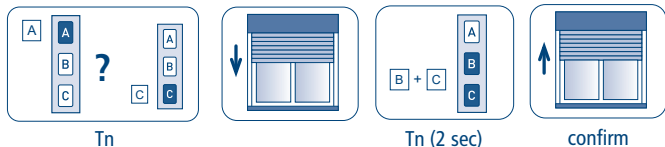

### SETTING THE OPENING POSITION

Pressing now button A, drive completely up the rolling shutter to the opening position.

**With physical stops:** press button A until the motor stops automatically.

**Without physical stops:** use the button A or C to drive the rolling shutter to the necessary opening position.

To set the opening position, press buttons A (up) and B (stop) simultaneously for about 2 seconds, until the motor automatically performs a short "down" movement.

This move is the visual confirmation of the setting operation.

Tn: Already programmed remote control

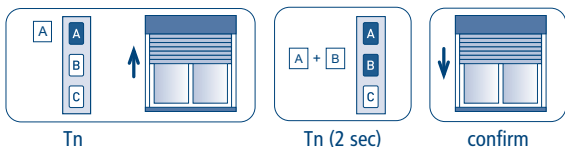

## SETTING A MIDDLE POSITION

This function allows the rolling shutter to be set at a favourite middle position. When this middle position is memorized, you just press the stop button for 2 seconds and automatically the motor will move the shutter to this position.

To memorize the middle position, move the rolling shutter to the desired position and then hold the STOP button down (for about 2 sec) until the motor gives confirmation.

Tn: Already programmed remote control



Tn (4 sec)

## DELETING THE MIDDLE POSITION

If you want to delete the middle position, it can be done as described below.

To change this position, it's also necessary to delete first the memorized middle position. Before deleting it's necessary to drive the motor to the middle position (by pressing button B for 2 seconds), then press again button B (stop) for about 4 seconds until the motor confirms the operation by a longer movement.

Tn: Already programmed remote control

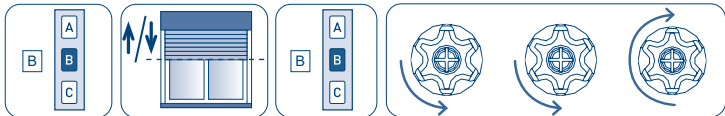

Tn (2 sec)

Tn (4 sec)

## CLOSING FORCE ADJUSTMENT

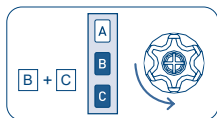

Tn

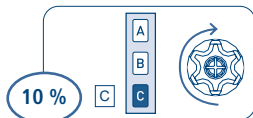
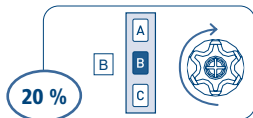
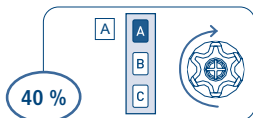
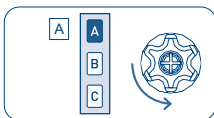

2 sec

This system is the only one of its kind and it guarantees that rolling shutters (which are equipped with lockdown hangers) remain perfectly closed without any danger of the slats suffering excessive pressure. The system works in all kinds of applications because of the opportunity of manually adjusting the closing force.

The motor is factory set to a closing force of 20 % of the nominal torque. This force can be changed very easily by the remote control. It can be reduced by 10 % or increased up to 40 %, depending on the desired result.

### MAXIMUM CLOSING FORCE ADJUSTMENT (100%)

A close attention on activating this function is recommended, excessive closing force may damage the rolling shutters.

By activating this function the motor will apply its maximum nominal torque, (e.g. 100% of 50 Nm = 50 Nm).

Tn: Already programmed remote control

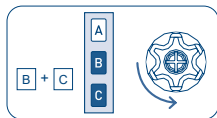

Tn

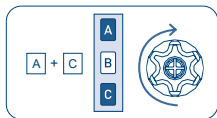
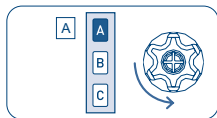

2 sec

## DELETING THE LIMIT SWITCH POSITIONS

### DELETING THE OPENING LIMIT SWITCH

To delete only the opening limit switch perform the following steps and proceed with "SETTING THE OPENING POSITION".

Tn: Already programmed remote control

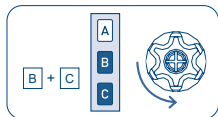

Tn

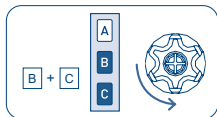

Tn

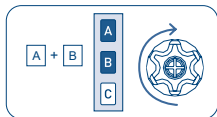

Tn (2 sec)

### DELETING THE CLOSING LIMIT SWITCH

To delete only the closing limit switch perform the following steps and proceed with "SETTING THE CLOSING POSITION".

Tn: Already programmed remote control

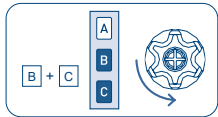

Tn

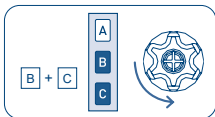

Tn

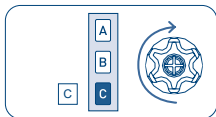

Tn (2 sec)

### TOTAL DELETING OF THE LIMIT SWITCHES

Tn: Already programmed remote control

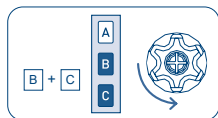

Tn

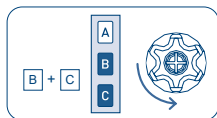

Tn

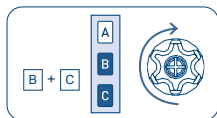

Tn (4 sec)

**NB:** by deleting the limit switches, the setting of the closing force is maintained.

## SETTING OF ADDITIONAL REMOTE CONTROLS

Up to 15 remote controls can be set.

Tn: Already programmed remote control

Tx: Additional remote control

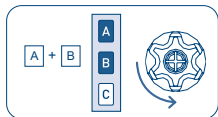

Tn

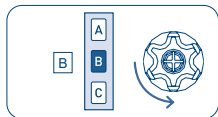

Tn

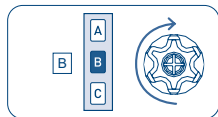

Tx (2 sec)

## REMOTE CONTROL MEMORY CLEARING

It is possible to delete singly all the memorized remote controls. When the last one is deleted the motor initial condition is restored. The same applies to the single channels of a multichannel remote control: just select the channel to cancel before performing the sequence.

Tn: Remote control to be cleared

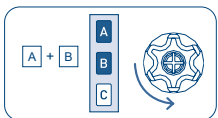

Tn

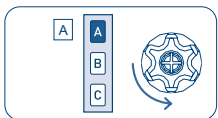

Tn

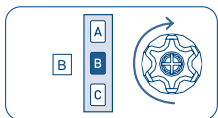

Tn (2 sec)



## FULL MEMORY CLEARING

This full memory clearing does not delete the setting of the limit switch.

The full memory clearing can be performed in two ways:

### 1) WITH THE REMOTE CONTROL

Tn: Already programmed remote control

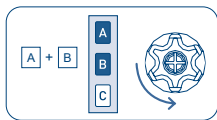

Tn

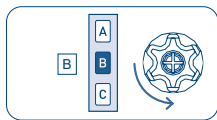

Tn

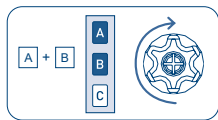

Tn (4 sec)

### 2) WITH THE WHITE WIRE

Do this operation only in case of emergency, if all remote controls are no longer operating. To delete the memory we have to access the white wire of the motor.

The sequence of this operation is the following:

- 1) Disconnect the power supply from the motor, via the main switch for example.
- 2) Connect the white motor wire to the brown wire (phase) or to the blue wire (neutral).
- 3) Connect the power supply to the motor, which rotates briefly in one direction.
- 4) Disconnect the power supply from the motor for at least 4 seconds.
- 5) Connect the power supply to the motor which performs one brief rotation in one direction after around 4 seconds and then a longer one in the opposite direction.
- 6) Disconnect the power supply from the motor.
- 7) Separate the white wire from the brow/blue wire. Insulate the white wire, in an appropriate way, before reconnecting the power supply.

At this point it is possible to proceed with the setting of the first remote control.

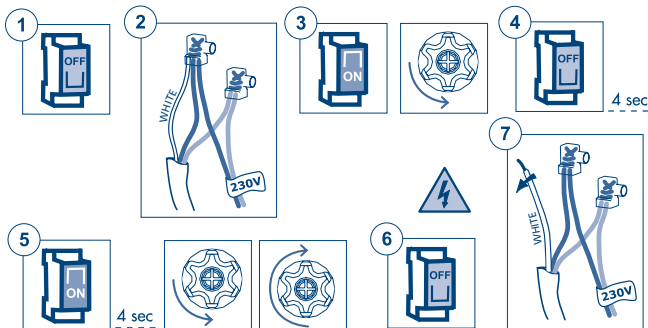

## SHORT-TERM SETTING OF A REMOTE CONTROL

This function makes it possible to store a remote control temporarily, for example, with the purpose of setting the limit switches during assembly in the factory. A later final saving of the remote control will be possible using the appropriate command sequence (see: "SETTING THE FIRST REMOTE CONTROL"). The operations described below can be carried out only when the motor has just come out of the factory or after a full memory clearing (see: "FULL MEMORY CLEARING"). The motor makes the following operations possible only within the time limits described in order to make sure that the short-term setting is used only in the installation or factory setting phase and not during daily use. Power up the motor, make sure that no other motors having an empty memory are powered up in the same operating range.

**Within 30 seconds after start**, press the B and C buttons simultaneously until the motor gives a confirmation signal.

**The remote control will remain stored for 5 minutes**, while the motor is powered up. After 5 minutes or when the motor has its power cut off, the remote control will be cancelled.

T1: First remote control to be set

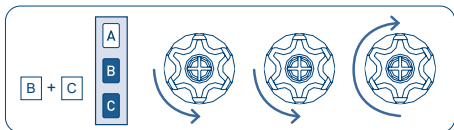

T1

## ELECTRIC WIRING TO MOTOR COMMAND FOR UP-DOWN MODE (2 independent UP-DOWN buttons)

To connect the switch, use only kind of switches with mechanical or electrical interlock, to prevent to press both buttons at same time.

The motor automatically recognizes the switch-type (with 1 or 2 buttons) and sets the proper operational mode.

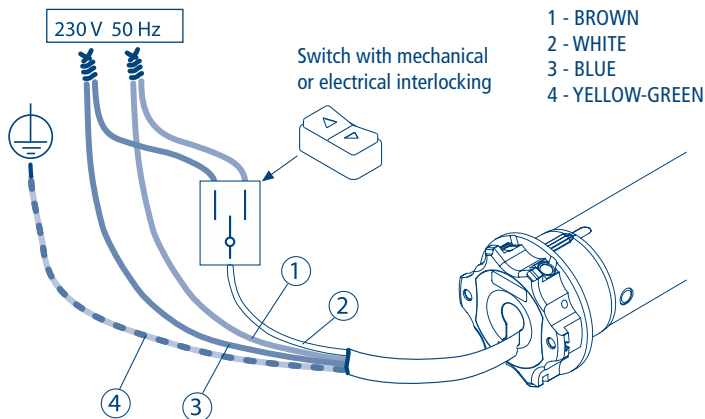

From white wire it's possible to control the motor in the middle position:

press UP long (> 2 s):

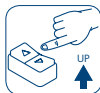

or use the short UP sequence (< 0,5 s) - short DOWN (< 0,5 s)



## COMMAND MANAGEMENT FROM WHITE WIRE

### UP-STOP-DOWN-STOP / UP-DOWN / UP-DOWN "DEAD MAN"

NB: The default function provided in the motors leaving the factory is UP-STOP-DOWN-STOP for singular UP/DOWN button switch. (Not for the switch with two independent UP-DOWN buttons!)

PROCEDURE TO CHANGE THE CONTROL MODE:

Tn: Already programmed remote control

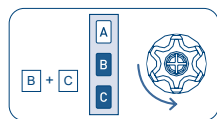

Tn

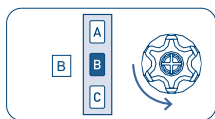

Tn

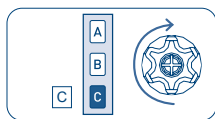

Tn (2 sec)

The possible settings are 3 and are available in the following order:

- UP-STOP-DOWN-STOP (factory setting)
- UP-DOWN (for 2 independent buttons)
- UP-DOWN "DEAD MAN" (for 2 independent buttons)

To switch from one setting to the following, perform the sequence as many times as necessary to reach the desired setting.

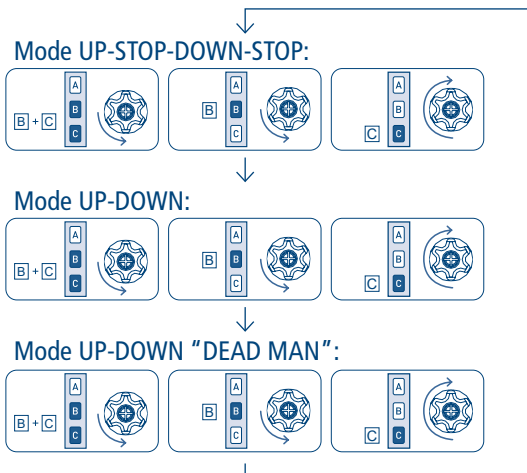



**CHERUBINI S.p.A.**

Via Adige 55  
25081 Bedizzole (BS) - Italy  
Tel. +39 030 6872.039 | Fax +39 030 6872.040  
info@cherubini.it | www.cherubini.it

**CHERUBINI Iberia S.L.**

Avda. Unión Europea 11-H  
Apdo. 283 - P. I. El Castillo  
03630 Sax Alicante - Spain  
Tel. +34 (0) 966 967 504 | Fax +34 (0) 966 967 505  
info@cherubini.es | www.cherubini.es

**CHERUBINI France S.a.r.l.**

ZI Du Mas Barbet  
165 Impasse Ampère  
30600 Vauvert - France  
Tél. +33 (0) 466 77 88 58 | Fax +33 (0) 466 77 92 32  
info@cherubini.fr | www.cherubini.fr

**CHERUBINI Deutschland GmbH**

Siemensstrasse, 40 - 53121 Bonn - Deutschland  
Tel. +49 (0) 228 962 976 34 / 35 | Fax +49 (0) 228 962 976 36  
info@cherubini-group.de | www.cherubini-group.de

